

**Guide**  
Ver.01b

## Beacon Gateway iGS03W/E/M User Manual

iGS03W/E/M is a gateway to bridge the local BLE( Bluetooth® Low Energy) tags, sensors, or beacons to remote server/cloud by WiFi, Ethernet or LTE-M. Through an easy web UI interface, user can configure the Internet access to upload reports to cloud server by TCP, HTTP(S), or MQTT(S). This guide is to help the user to figure out how to operate and configure the iGS03.



### Contents:

#### [Overview](#)

[Block Diagram](#)

[SIM](#)

[WiFi \(iGS03W/iGS03M\)](#)

[Ethernet \(iGS03E\)](#)

[BLE](#)

[GNSS \(iGS03M\)](#)

[Example case 1: The device is in fixed position:](#)

[Example case 2: The device is moving:](#)

#### [Payload Format](#)

[BLE](#)

[GNSS \(iGS03M\)](#)

#### [Button](#)

[Reset to Default](#)

[WPS](#)

#### [LEDs](#)

#### [Configuration](#)

[iGS03W & iGS03M](#)

[iGS03E](#)

#### [Web User Interface](#)

[System](#)

[Wi-Fi](#)

[AP Mode](#)

[Station Mode](#)

[Network](#)

[WiFi Address \(Device Address for IGS03E\)](#)

# INGICS TECHNOLOGY

[DHCP Server \(WiFi AP\)](#)

## [Applications](#)

[TCP Server](#)

[TCP Client](#)

[HTTP Client](#)

[MQTT Client](#)

## [Common Settings](#)

[Content Type](#)

[Keep Alive](#)

[Append Timestamp](#)

[Request Interval](#)

[Cache full handling](#)

[Throttle Control](#)

## [Cloud IoT Helper](#)

## [Advanced](#)

### [BLE Configuration](#)

[BLE PHY Mode](#)

[Active Scan Mode](#)

### [BLE Filter](#)

[RSSI Threshold](#)

[Payload Whitelist](#)

[BLE MAC Whitelist](#)

## [Security](#)

[Device Key/Certification/Server CA Upload](#)

## [LTE](#)

### [LET Settings](#)

[Access Point Name](#)

[Authentication](#)

[Username/Password](#)

[DNS Servers](#)

### [GNSS Settings](#)

## [NTP Setting](#)

## [Login Password](#)

## [Waste Electrical and Electronic Equipment Recycling](#)

## [Certification](#)

[Bluetooth SIG Qualification](#)

[Japan MIC Regulatory](#)

[FCC Regulatory](#)

[Statements](#)

[CE Regulatory](#)

## [Revision History](#)

## Overview

The iGS03 BLE gateway scans beacons(like iBeacon or Eddystone), proprietary tags, or BLE sensors then sends the payload to TCP, HTTP or MQTT server. Users can configure the transmit period

# INGICS TECHNOLOGY

and server endpoint through a simple web UI. There are three models, iGS03W, iGS03E and iGS03M, representing different uploading interfaces, WiFi, Ethernet and LTE-M.

## Block Diagram

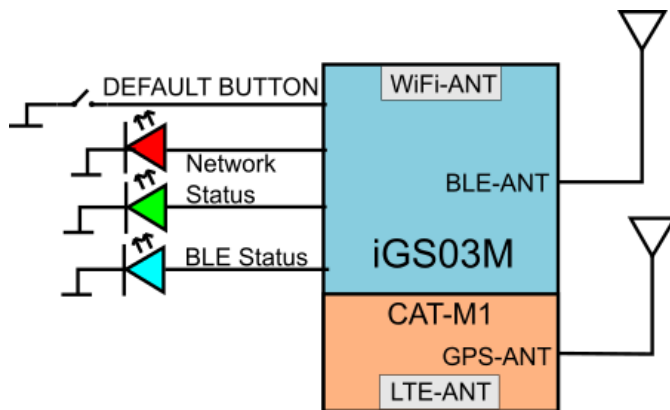
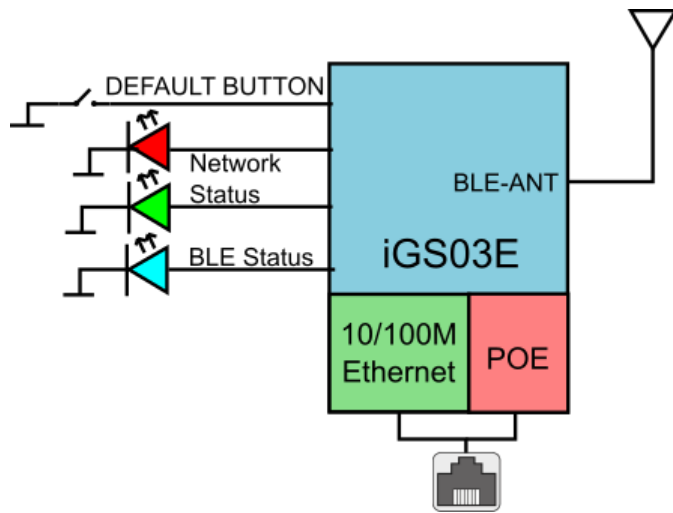
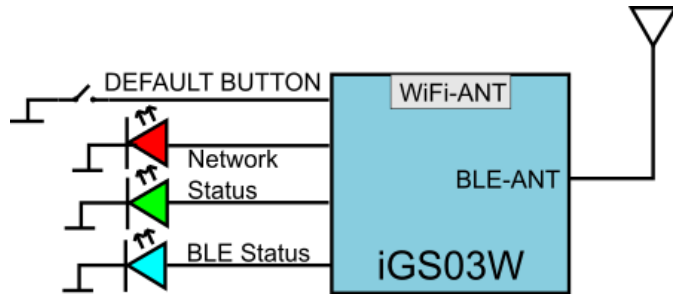



# INGICS TECHNOLOGY



## SIM

To use iGS03M (LTE-M Model), you have to put a Cat-M1 micro SIM card into the socket of iGS03M. Please open the bottom cover to insert the SIM card. The steps to open the bottom cover are as below,

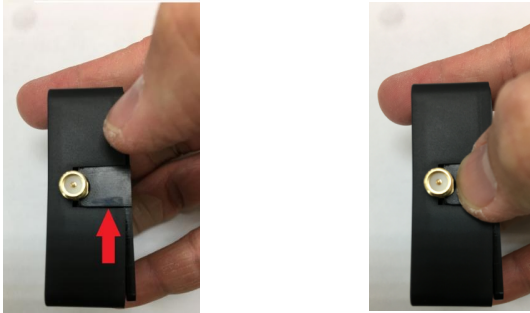
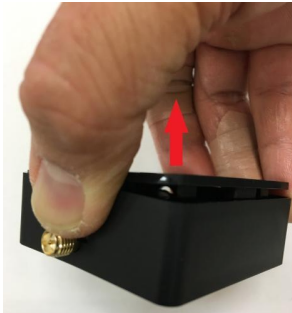
Step 1. Remove external BLE antenna	Step 2. Remove the screw from bottom cover
	
Step 3. Use finger to press and hold the arrow part	Step 4. Pull out the bottom cover
	

## WiFi (iGS03W/iGS03M)

The 2.4G WiFi AP connection is used to configure the unit through web UI. iGS03 works as an WiFi Access Point(AP) supporting DHCP. Users must connect to this AP to configure the unit.

## Ethernet (iGS03E)

It supports 10BASE-T and 100BASE-TX with HP Auto-MDIX. Through the Ethernet, the gateway can bridge your BLE devices to the local TCP server or cloud server for management.

## BLE

The BLE subsystem operates in listening mode. It collects the messages advertised by BLE devices. These messages are then sent to the cloud server configured by the user.

iGS03 supports two BLE modes

1. LE 1M PHY: including BLE4.2(Legacy)/BLE5, 1M in 100% duty cycle
2. LE Coded PHY: BLE5, 125K(Long Range) in 100% duty cycle

The default PHYMODE is 1, LE 1M PHY mode.

Users can use webUI or telnet command to configure the mode.

## GNSS (iGS03M)

The GNSS function is turned "off" by default. Users can use webUI to enable or disable GNSS.

For detail settings, use below telnet commands to manage the GNSS behavior:

GNSS ENABLE    Enable/Disable GNSS, default off

GNSS FIXCOUNT    Number of attempts for positioning, 0 indicates continuous positioning.

default 0

GNSS FIXRATE    The interval time between the first and second time positioning, default 1 (1 second)

GNSS RPTRATE    The interval time for sending GPSR report, default 600 (10 minutes)

GNSS INFO    To get latest GPS status

Example case 1: The device is in fixed position:

e.g.

# INGICS TECHNOLOGY

GNSS ENABLE 1

GNSS FIXCOUNT 5

GNSS FIXRATE 60

GNSS RPTRATE 60

Then GNSS will be enabled and get positioned for 5 times with a 60 seconds interval.

GNSS will be off automatically after getting position for 5 times.

Example case 2: The device is moving:

e.g.

GNSS ENABLE 1

GNSS FIXCOUNT 0

GNSS FIXRATE 1

GNSS RPTRATE 60

Then GNSS will be enabled and continuously get position with 1 second interval, and it will send a GPSR report every 60 sec.

You can also use the "GNSS INFO" command to get the latest coordinates.

## Payload Format

There are several kinds of payload format that iGS03 will send to the server.

### BLE

General format:

```
$<report type>,<tag id>,<gateway id>,<rssi>,<raw packet content>,*<unix epoch timestamp>\r\n
```

<report type>	Different report type to distinguish the source of the report.
<tag id>	MAC address or ID of tag/beacon
<gateway id>	MAC address of gateway
<rssi>	RSSI of tag/beacon
<raw packet content>	Raw packet received by the gateway
<unix epoch timestamp>	Optional timestamp configured in applications page

Report Type:

\$GPRP      BLE4.2 General Purpose Report

# INGICS TECHNOLOGY

\$RSPR	BLE4.2 Scan Response Report
\$LRAD	BLE5 Long Range ADV
\$LRSR	BLE5 Long Range Scan Response
\$1MAD	BLE5 1M ADV
\$1MSR	BLE5 1M Scan Response

## Examples:

```
$GPRP,CCB97E7361A4,CB412F0C8EDC,-49,1309696773206D65736820233220285445535429020106,1574921085
$GPRP,E5A706E3923A,CB412F0C8EDC,-87,0201041AFF590002150112233445566778899AABBCCDDEEFF0000100C3BB,1574921085
$LRAD,51A88AD374B7,CC4B73906F96,-87,02010212FF0D0083BC280100AAAAFFFF000010030000,1574921085
$GPRP,0C61CFC1452E,E7DAE08E6FC3,-44,0201061AFF4C000215B9A5D27D56CC4E3AAB511F2153BCB9670001452ED6
(iBeacon, UUID: B9A5D27D56CC4E3AAB511F2153BCB967, Major: 0001, Minor: 452E)
```

## GNSS (iGS03M)

General format:

```
$GPSR,<tag_mac>,<reader_mac>,<rssi>,yymmdd,hhmmss.ss,latitude,longitude,speed,hdop,(timestamp)
```

- "\$GPSR,<tag\_mac>,<reader\_mac>,<rssi>" fields are for compatibility with other reports. The tag\_mac is always the same as reader\_mac and the rssi is always -127.
- yymmdd,hhmmss.ss is the UTC time when the position is acquired.
- speed: The unit is knots.
- hdop: Horizontal dilution of position

## Example:

```
$GPSR,CC4B73906F96,CC4B73906F96,-127,191127,233821.00,24.993631,121.423264,0.0,2.4,1574897900
```

## Button

One button is located on the back panel. It is used for WPS function or Reset to default settings.

Function	Trigger Condition
WPS (iGS03W/M)	short press for over 1sec and release
Reset to default settings	long press for over 3 sec

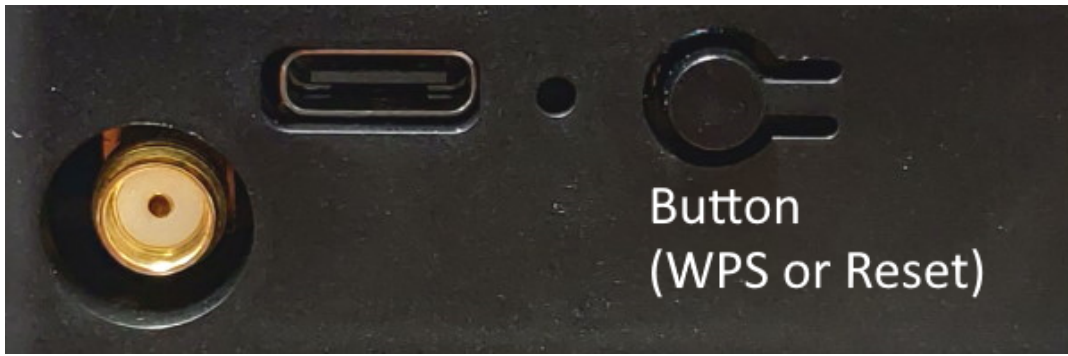

## Reset to Default

Pressing the reset button on your device for over 3 secs to retrieve the default setting. While the network status LED turns into red light, release the button, and the iGS03M will reboot with its default settings.

## WPS

Users can use the WPS button to join iGS03W/M to the WiFi Access Point. First press the WPS button on your Access Point, when it is ready, then press the WPS button for over 1 sec on the iGS03M device to join the Access Point.

## LEDs

There are two LEDs indicating the current status. The left one is BLE status LED and the right one is Network status. Below are their behaviors.

	On	Flash
BLE Status LED	find tag/beacon in range	BLE transmission happening
Network Status LED	WiFi/LTE-M connection success (This only implies the network is connected. It doesn't mean the server is connected)	<b>Green:</b> WiFi/LTE-M network transmission happening <b>Orange:</b> If IGS03M does not insert SIM card and being used as WiFi device



Network Status LED behavior	Description	Status
-----------------------------	-------------	--------



<b>ORANGE</b> LED on (500ms)	Boot start	Booting
<b>RED</b> LED blink (100ms on/off)	Joining AP (If WiFi in STA mode)	Booting
<b>RED</b> LED blink (500ms on/off)	LTE connecting carrier	Booting
<b>GREEN/ORANGE</b> LEDs blink interleaved (100ms)	WPS enrollee	WPS
<b>GREEN</b> LED on	Network ready	Ready/Idle
<b>ORANGE</b> LED on	Network ready (If SIM card is not inserted)	Ready/Idle
<b>GREEN</b> LED blink (200ms on/off)	Network is transferring data (If SIM card is not used on iGS03M, shows <b>ORANGE</b> LED blink instead)	Busy
<b>RED</b> LED ON (1sec)	Connect failure	Error
<b>RED</b> LED blink (5sec on/off)	Misconfiguration	Error
<b>RED</b> LED ON (5sec)	LTE init failure	Error

## Configuration

### iGS03W & iGS03M

To configure the unit, you have to connect it through the WiFi interface. When it is powered on, you could scan its native AP and connect it with the WiFi of your NB/PC/Mac/Tablet/Smartphone. Its SSID is just like the below figure with part of the mac address. The default key to connect with it is “**12345678**”. You can change it later when you get into the web UI.



After connection, enter IP address **192.168.10.1** in your browser. The default account/password are both “**admin**”. The following sections describe details of the web UI.

### iGS03E

iGS03E is a DHCP client by default. To configure it, you have to connect it to a router with DHCP enabled. The first thing is to find iGS03E’s IP address in this network so that you can get into it’s webUI for configuration. If you don’t know the IP address, you may need to use some tool to find it. (For example, “Fing” APP in Android & iOS. Join your smartphone or tablet with “Fing” in the same network. And use it to scan all the devices in this network)

## Web User Interface

You can review current configuration or modify it on the web UI. There are various function groups listed on the top of UI.

SYSTEM    WIFI    NETWORK    LTE    APPLICATION    ADVANCED    SECURITY

Any change in the page needs to be saved first before switching to another page, otherwise the modification will be lost. And after all changes made, click reboot to make the changes effective.

Require reboot for the changes to take effect.

REBOOT

## System

Display firmware and device information, including MAC address and IP address in station mode are shown here.

## Wi-Fi

Users can configure iGS03M's WiFi device as an WiFi AP or join to the other AP. The related settings can be managed on this page.

### AP Mode

**SSID:** The default name is IGS03 plus the last digits of the mac address.

**Security:** Open, WPA-PSK, WPA2-PSK and WPA-PSK/WPA2-PSK are supported. WPA2-PSK is recommended.

**Password:** 8-63 characters can be input

**Channel:** 1~11(ch12 and ch13 could be supported by request)



AP Settings

SSID  
IGS03M\_18\_C4

Security: WPA2-PSK    Channel: 6

Password: [masked] [toggle icon]

### Station Mode

This mode is used for transferring data by \*WiFi.

**Scan:** Click it to scan available APs.



AP Client Settings

SSID  
TargetAP    SCAN

Security: WPA2-PSK

Password: [masked] [toggle icon]

The scan result list will be displayed on the popup window, and the user can choose the correct AP from the list.

**SSID:** No manual input required. It is automatically filled once a user chooses an AP from the scan result list.

**Security:** Basically it is automatically detected and selected after choosing an AP from the scan list. But in case the AP setting is in WEP open or WEP shared, the user has to confirm it by himself/herself.

**Password:** Type the one assigned in your AP.

**\*Note:** *In data transfer, by default, WiFi has higher priority than LTE. So for iGS03M if both interfaces are configured correctly and connected, the data will be transferred by WiFi. Users can change the priority through the Telnet command.*

## Network

### WiFi Address (Device Address for IGS03E)

This setting is for configuring in WiFi Station mode or IGS03E. Normally the “DHCP Client” is used to obtain an IP Address from WiFi AP (or DHCP server for ethernet). If one wants to manually assign an IP address for iGS03, choose “Static IP” to assign the IP Address, Netmask, Gateway, and/or DNS servers.

WiFi Address	
Mode	DHCP Client
WiFi Address	
Mode	Static IP
IP Address	Netmask
192.168.0.1	255.255.255.0
Default Gateway	
192.168.0.254	
DNS Server 1	DNS Server 2
8.8.8.8	1.1.1.1

### DHCP Server (WiFi AP)

The default IP address of iGS03 in WiFi AP mode is 192.168.10.1 and the netmask is 255.255.255.0. In case the user wants to change the IP address in AP mode, just set the IP and Netmask here. The corresponding DHCP client address will be changed too. For example, if the DHCP server IP address is changed to 192.168.0.1., the DHCP

DHCP Server (WiFi AP)	
IP Address	192.168.10.1
Netmask	255.255.255.0

clients associated with iGS03 AP will be 192.18.0.X.

## Applications

### TCP Server

This mode is mainly for testing purposes. Users can check the received data immediately via connecting to the TCP server through WiFi interface.



The screenshot shows a configuration window for TCP Server. It has a dropdown menu for 'Mode' set to 'M2M (TCP Server)'. Below it is a text input field for 'Port' containing the value '8080'.

### TCP Client

iGS03 plays as a TCP client to communicate with a raw TCP server. Enter the address and port number of the TCP server to connect it.

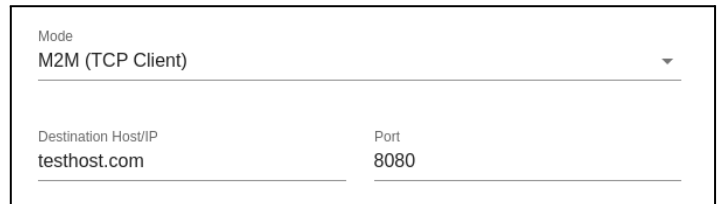

The screenshot shows a configuration window for TCP Client. It has a dropdown menu for 'Mode' set to 'M2M (TCP Client)'. Below it are two text input fields: 'Destination Host/IP' containing 'testhost.com' and 'Port' containing '8080'.

### HTTP Client

Another connection in application is through setting iGS03 as a HTTP client. In this scenario, one has to assign the HTTP URL to bring the BLE data to the HTTP server through the gateway. Some HTTP servers may need username and password. The others may need extra header and value.

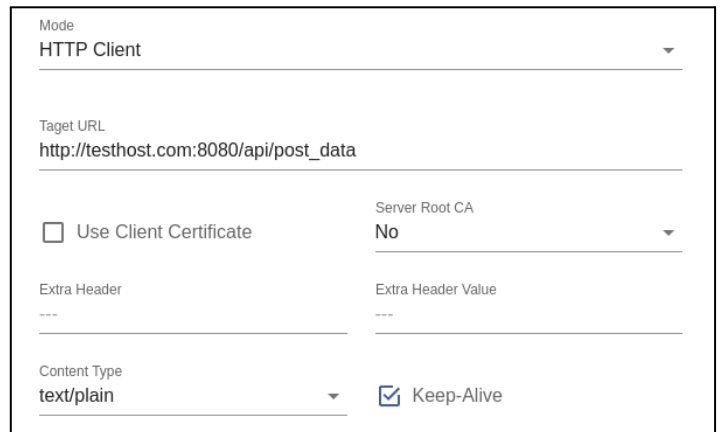

The screenshot shows a configuration window for HTTP Client. It has a dropdown menu for 'Mode' set to 'HTTP Client'. Below it is a text input field for 'Target URL' containing 'http://testhost.com:8080/api/post\_data'. There are two checkboxes: 'Use Client Certificate' (unchecked) and 'Server Root CA' (set to 'No'). Below these are two text input fields for 'Extra Header' and 'Extra Header Value', both containing '---'. At the bottom, there is a dropdown for 'Content Type' set to 'text/plain' and a checked checkbox for 'Keep-Alive'.

Users can simply use https:// in URL to enable HTTPS. And users can also enable Server Root CA/User Client Certificate based on the server requirement. The certificate files can be uploaded on the Security page.

## MQTT Client

Configure iGS03 to connect MQTT broker for publishing data. In this scenario, one has to assign the MQTT host address and port number. Also the publish topic needs to be assigned. Client ID is defaultly assigned as the gateway name with part of MAC address, users can change it as well. If the Client ID is not set, the system will generate a random number for it. Username and password are optional.

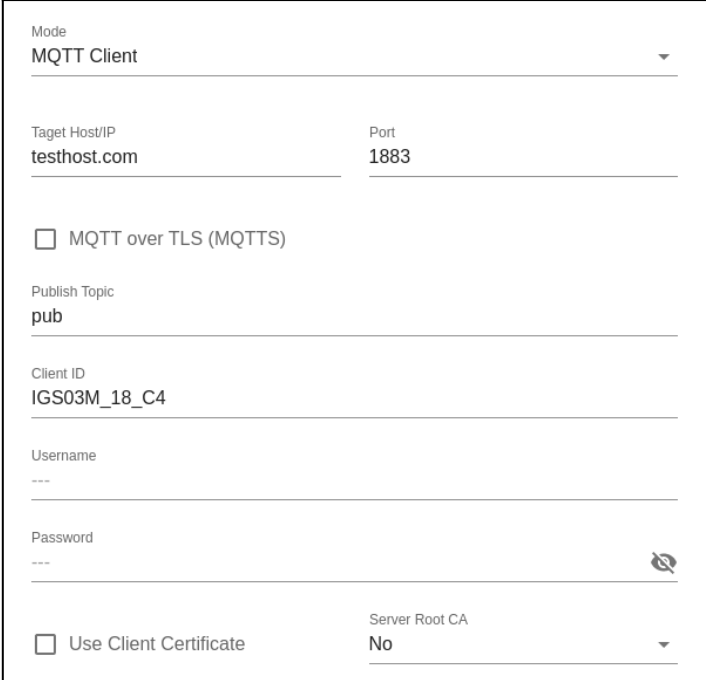

The screenshot shows a configuration form for an MQTT Client. The form is titled "MQTT Client" and has a dropdown menu for "Mode" set to "MQTT Client". Below this, there are two input fields: "Target Host/IP" with the value "testhost.com" and "Port" with the value "1883". There is a checkbox for "MQTT over TLS (MQTTS)" which is currently unchecked. Below that is a "Publish Topic" field with the value "pub". The "Client ID" field contains "IGS03M\_18\_C4". The "Username" field is empty and has a placeholder "---". The "Password" field is also empty and has a placeholder "---" and a toggle icon for visibility. At the bottom, there is a checkbox for "Use Client Certificate" which is unchecked, and a "Server Root CA" dropdown menu set to "No".

Users can enable MQTTS support. And also can enable Server Root CA/Use Client Certificate based on the server requirement. For example, to enable AWS-IOT, the user has to enable MQTTS/ROOT CA/ Use Certificate options and upload certificate and private key in the security page.

## Common Settings

### Content Type

Users can choose the report data in plain text format or JSON string.

### Keep Alive

This option is available for HTTP clients. The device will use HTTP persistent connection to reuse existing tcp sessions. This enhances the HTTP efficiency.

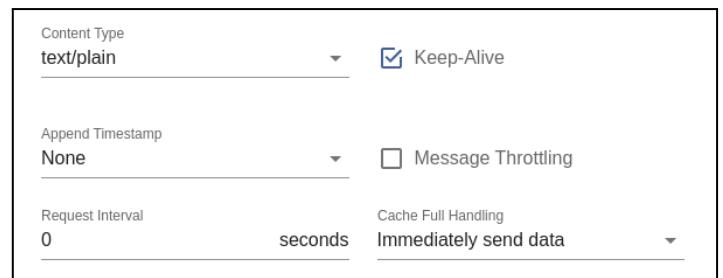

The screenshot shows a configuration panel with the following settings:

- Content Type: `text/plain` (dropdown menu)
- Append Timestamp: `None` (dropdown menu)
- Request Interval: `0` (input field) with the unit `seconds` (dropdown menu)
- Cache Full Handling: `Immediately send data` (dropdown menu)
- Keep-Alive:  (checkbox)
- Message Throttling:  (checkbox)

### Append Timestamp

Devices add the timestamp information in the BLE package format as stated on the page. Users can choose to use the unit in seconds or milliseconds. If the device did not enable NTP time synchronization or the NTP server is unreachable, the report timestamp will be unexpected.

### Request Interval

One can also assign the request interval to upload the data to the server. This is useful for reducing data connections. When the interval is set as 0, the data will be sent immediately. When it is set as a non-zero value in second, the data will be sent whenever the buffer is full (depends on Cache full handling option) or the time interval is reached.

### Cache full handling

The iGS03 has a limited cache buffer. The user needs to decide “sending data immediately” or “discard new input data” if cache is full.

- If the user selects "sending data immediately", the device will keep on uploading data when cache is full to avoid data loss regardless of your "request interval setting". That will cause more data traffic.
- If the user selects "discard new input data", the device will not send data before reaching the request interval.

### Throttle Control

If throttle control is enabled, iGS03 will keep the last record for each TAG/Beacon ID in the given interval (request interval). In this way, one can reduce the data transmission to the server.

## Cloud IoT Helper

The cloud IoT helper can be launched by the “magic wand”, it is used to assist users to configure AWS IoT, Azure IoT or Google Cloud IoT usage.

## Advanced

### BLE Configuration

#### BLE PHY Mode

Users can choose to use LE 1M PHY or LE Coded PHY (Long-Range Mode).

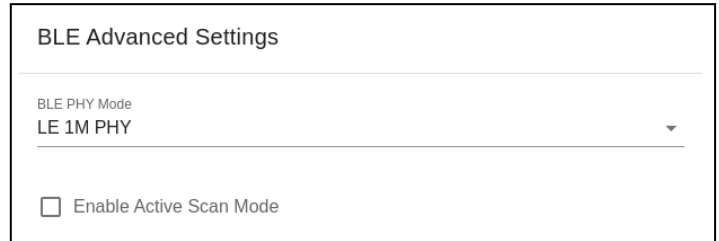

The screenshot shows a dialog box titled "BLE Advanced Settings". It contains a dropdown menu for "BLE PHY Mode" currently set to "LE 1M PHY". Below the dropdown is a checkbox labeled "Enable Active Scan Mode" which is currently unchecked.

#### Active Scan Mode

Enable active scanning.

### BLE Filter

Users can set the BLE filter to filter out the unwanted BLE advertising data. There are three kinds of filters supported by iGS03.

#### RSSI Threshold

If the bar is pulled right to -50dBm, only the BLE tag/beacon with RSSI larger than or equal to -50dBm will be transmitted to the server.

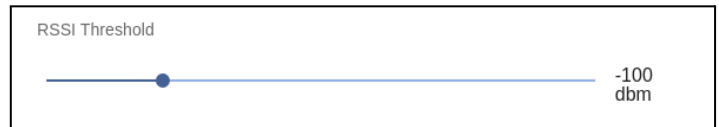

The screenshot shows a slider control titled "RSSI Threshold". The slider bar is horizontal and has a blue dot indicating the current threshold. The right end of the slider is labeled "-100 dbm".

#### Payload Whitelist

Set patterns to configure the BLE payload whitelist. Devices will only report the BLE payload which matches one of the patterns.

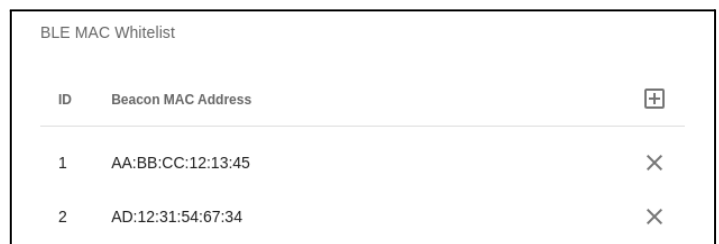

The screenshot shows a table titled "BLE MAC Whitelist". It has two columns: "ID" and "Beacon MAC Address". There are two rows of data. The first row has ID "1" and MAC Address "AA:BB:CC:12:13:45". The second row has ID "2" and MAC Address "AD:12:31:54:67:34". There is a plus sign icon in the top right corner and an 'X' icon in the right column of each row.

ID	Beacon MAC Address
1	AA:BB:CC:12:13:45
2	AD:12:31:54:67:34

Click on the “plus” button to add a new pattern. The character ‘X’ in pattern means ignore the character. Also you can click the “magic wand” to select a preset pattern for iBeacon, Eddystone, or INGICS beacons.



The screenshot shows a dialog box titled "Payload Pattern". It contains a text input field with the value "0123456789ABCDEFX". Below the input field is a small icon of a magic wand. Below the input field is the text "HEX string for payload matching, 'X' for ignore". At the bottom right are "CANCEL" and "OK" buttons.

Users can set up to 6 entries of the payload filter to make sure only relevant information is received. If the pattern list is empty, it means the payload whitelist function is disabled, all payload will be allowed.

## BLE MAC Whitelist

Set BLE beacon MAC addresses to configure the BLE MAC whitelist.

Gateway will only report the advertising data broadcasted from the beacons which match the whitelist.

Payload Filter (Whitelist)		
ID	Payload Match Pattern	
1	0201061AFF4C00	×
2	020106XXFF5900XXBC	×

Users can set up to 10 MACs to make sure only relevant information is received. If the list is empty, it means the BLE MAC whitelist function is disabled. All BLE beacons are allowed.

## Security

### Device Key/Certification/Server CA Upload

Users can upload device certification, private key and server CA files in PEM format on this page. All these files may be used by MQTTS or HTTPS functions.

## LTE

### LET Settings

#### Access Point Name

The APN setting for the carrier setting.

#### Authentication

The auth type based on the carrier setting.

#### Username/Password

The username/password based on the carrier setting.

#### DNS Servers

In case the users want to specify

LTE Settings	
Access Point Name	internet.iot
Authentication	PAP
Username	
Password	
DNS 1	
DNS 2	
GNSS Settings	
<input type="checkbox"/> Enabled	



his/her own DNS servers.

## GNSS Settings

Users can enable the GNSS function here.

## NTP Setting

To open the NTP Setting UI, click the “clock” icon in the UI header. User has to set the time server and the update period to enable NTP.

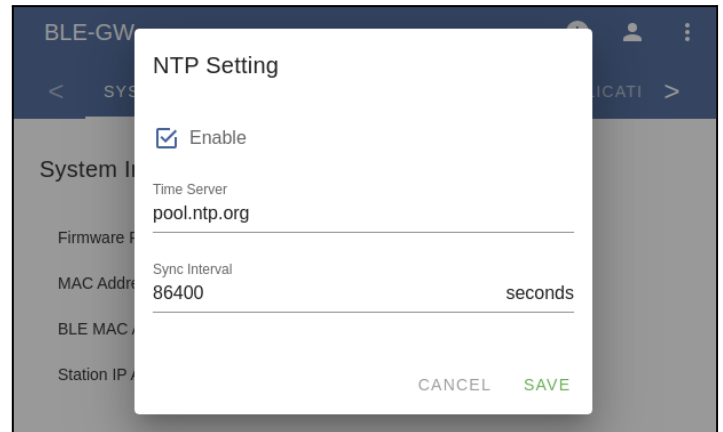

## Login Password

One can change the login password from the “people” icon on the UI header. Be aware that it changes the login password of the telnet console, too.

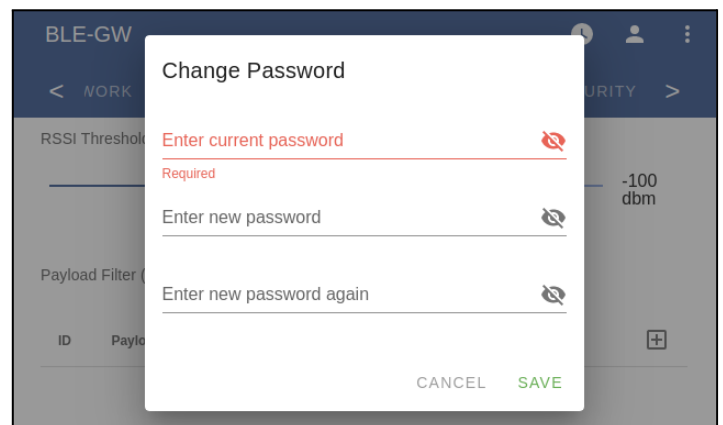

## Waste Electrical and Electronic Equipment Recycling

Our product is compliant with the WEEE directive for re-use/recovery/recycling. This cross-out wheeled-bin symbol is a reminder that this product should not be treated as household waste. Instead hand it over to the appropriate collection point for the recycling of electrical and electronic equipment in accordance with local environmental regulations for waste disposal.



Since our product is not sold directly to the end user and generally it is a part of our customer’s solution, our customer is recognized as a professional seller. Our customer has the responsibility to comply with the requirement of the directive too. To help our customers, when necessary, we will provide a WEEE compliant assessment report for registering and communicating with the local authorities and recycling agency.



## Certification

### Bluetooth SIG Qualification

Model number: iGS03W/iGS03M  
Declaration ID: D048813  
Description: Beacon gateway

### Japan MIC Regulatory

iGS03W with below certified number  
201-200584, 217-204070

iGS03E with below certified number  
201-210049, 217-204070

iGS03M with below certified number  
201-200584, 217-204070, 003-180062,  
D180034003

### FCC Regulatory

iGS03W  
FCC ID:2AH2IIGS03W  
contains  
FCC ID:2AC7Z-ESP32WROOM32E

iGS03E  
FCC ID:2AH2IIGS03E  
contains  
FCC ID:2AC7Z-ESP32WROOM32E

iGS03M  
FCC ID:2AH2IIGS03W  
contains  
FCC ID:XMR201707BG96  
FCC ID:2AC7Z-ESP32WROOM32E

## Statements

### Federal Communication Commission Interference Statement

This equipment has been tested and found to comply with the limits for a Class B digital device, pursuant to Part 15 of the FCC Rules. These limits are designed to provide reasonable protection against harmful interference in a residential installation.

This equipment generates, uses and can radiate radio frequency energy and, if not installed and used in accordance with the instructions, may cause harmful interference to radio communications. However, there is no guarantee that interference will not occur in a particular installation. If this equipment does cause harmful interference to radio or television reception, which can be determined by turning the equipment off and on, the user is encouraged to try to correct the interference by one of the following measures:

- . Reorient or relocate the receiving antenna.
- . Increase the separation between the equipment and receiver.
- . Connect the equipment into an outlet on a circuit different from that to which the receiver is connected.
- . Consult the dealer or an experienced radio/TV technician for help.

**FCC Caution:** To assure continued compliance, any changes or modifications not expressly approved by the party responsible for compliance could void the user's authority to operate this equipment. (Example - use only shielded interface cables when connecting to computer or peripheral devices).

### FCC Radiation Exposure Statement

This equipment complies with FCC RF radiation exposure limits set forth for an uncontrolled environment. This equipment should be installed and operated with a minimum distance of 20 centimeters between the radiator and your body.

This transmitter must not be co-located or operating in conjunction with any other antenna or transmitter.

The antennas used for this transmitter must be installed to provide a separation distance of at least 20 cm from all persons and must not be co-located or operating in conjunction with any other antenna or transmitter.

This device complies with Part 15 of the FCC Rules. Operation is subject to the following two conditions:

- (1) This device may not cause harmful interference, and
- (2) This device must accept any interference received, including interference that may cause undesired operation

## CE Regulatory

iGS03W/M has been tested and complies with the essential requirements of the DIRECTIVE 2014/53/EU and DIRECTIVE 2014/35/EU. Below is the copy of CE Conformity of Declaration.

## DECLARATION OF CONFORMITY

Under EU RED - DIRECTIVE 2014/53/EU -  
Under EU-LOW VOLTAGE DIRECTIVE 2014/35/EU

This declares that the following designated product

**BLE Beacon Gateway**  
**Model No.: iGS03W**  
**Brand Name: INGICS**

.....  
(Product identification)

complies with the essential requirements of the **EU RED - DIRECTIVE 2014/53/EU, EU-LOW VOLTAGE DIRECTIVE 2014/35/EU** on the approximation of the laws of the Member States relating to **Radio Spectrum Matters/RF Exposure/Health Matters**.

Assessment of compliance of the product with the requirements relating to radio spectrum matters was based on Annex IV of the Directive **2014/53/EU** and the following standard:

<b>EMC</b>	<b>Radio Spectrum</b>	<b>Safety</b>
<b>EN 301 489-1: V 2.2.3 (2019-11)</b>	<b>EN 300 328: V 2.2.2 (2019-07)</b>	<b>IEC 62368-1: 2014/COR1:2015</b>
<b>EN 301 489-17: V 3.2.4 (2020-09)</b>		<b>and EN 62368-1: 2014/A11:2017</b>
		<b>Health</b>
		<b>EN 62311 (2020)</b>

.....  
(Identification of regulations / standards)

This declaration is issued by  
**INGICS TECHNOLOGY.**  
**2F., No.15-2, Changshou St.,**  
**Shulin Dist., New Taipei City 238,, Taiwan, R.O.C.**

.....  
(Name / Address)

Furthermore we declare that our product will be produced in correspondence with all requirements according to the Directive 2014/53/EU and LOW VOLTAGE DIRECTIVE 2014/35/EU.

Name: J.K.Fan

Title: President

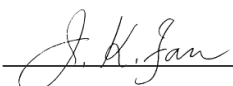
Signature 

Date: 2020. 11.16

## DECLARATION OF CONFORMITY

Under EU RED - DIRECTIVE 2014/53/EU -  
Under EU-LOW VOLTAGE DIRECTIVE 2014/35/EU

This declares that the following designated product

**LTE Beacon Gateway**  
**Model No.: iGS03M**  
**Brand Name: INGICS**

.....  
(Product identification)

complies with the essential requirements of the **EU RED - DIRECTIVE 2014/53/EU, EU-LOW VOLTAGE DIRECTIVE 2014/35/EU** on the approximation of the laws of the Member States relating to **Radio Spectrum Matters/RF Exposure/Health Matters**.

Assessment of compliance of the product with the requirements relating to radio spectrum matters was based on Annex IV of the Directive **2014/53/EU** and the following standard:

<b>EMC</b> EN 301 489-1: V 2.2.3 (2019-11) EN 301 489-17: V 3.2.4 (2020-09) EN 301 489-19: V 2.1.1 (2019-04) EN 301 489-52: V 1.1.0 (2016-11) <b>Draft</b>	<b>Radio Spectrum</b> EN 300 328: V 2.2.2 (2019-07) EN 303 413: V1.1.1 (2017-06) EN 301 908-1: V13.1.1 (2019-11)	<b>Safety</b> IEC 62368-1: 2014/COR1:2015 and EN 62368-1: 2014/A11:2017
		<b>Health</b> EN 50385 (2017)

.....  
(Identification of regulations / standards)

This declaration is issued by  
**INGICS TECHNOLOGY.**  
**2F., No.15-2, Changshou St.,**  
**Shulin Dist., New Taipei City 238,, Taiwan, R.O.C.**

.....  
(Name / Address)

Furthermore we declare that our product will be produced in correspondence with all requirements according to the Directive 2014/53/EU and LOW VOLTAGE DIRECTIVE 2014/35/EU.

Name: J.K.Fan Title: President

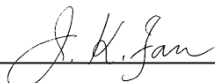
Signature 

Date: 2020. 11.16

## DECLARATION OF CONFORMITY

EU RED - DIRECTIVE 2014/53/EU -  
EU-LOW VOLTAGE DIRECTIVE 2014/35/EU -  
EU EMC-DIRECTIVE 2014/30/EU -

This Declaration that the following designated product

**BLE Beacon Gateway**  
**Model No.: IGS03E**  
**Brand Name: INGICS**

.....  
complies with the essential requirements of the **EU RED - DIRECTIVE 2014/53/EU, EU-LOW VOLTAGE DIRECTIVE 2014/35/EU, EU EMC-DIRECTIVE 2014/30/EU** on the approximation of the laws of the Member States relating to **Radio Spectrum Matters/RF Exposure**.  
Assessment of compliance of the product with the requirements relating to radio spectrum matters was based on Annex IV of the Directive **2014/53/EU** and the following standard:

<b>EMC</b>	<b>Radio Spectrum</b>	<b>Safety</b>
EN 301 489-1: V 2.2.3 (2019-11) EN 301 489-17: V 3.2.4 (2020-09)	EN 300 328 V 2.2.2: 2019-07	IEC 62368-1: 2014/COR1:2015 and EN 62368-1:2014/A11:2017
		<b>Health</b> EN 62479 (2010)

**EMC**  
EN 55032 Class B (2015A/A11:2020),  
EN55035 (2017/A11:2020), ((IEC/EN61000-4-2 (2009)/-3 (2020)/-4 (2012)/  
-6 (2014)/-8 (2010))

.....  
This declaration is issued by  
**INGICS TECHNOLOGY.**  
**2F., No.15-2, Changshou St.,**  
**Shulin Dist., New Taipei City 238., Taiwan, R.O.C.**

.....  
Furthermore we declare that our product will be produced in correspondence with all requirements according to the Directive 2014/53/EU, LOW VOLTAGE DIRECTIVE 2014/35/EU and Council Directive 2014/30/EU.

Name: J.K.Fan

Title: President

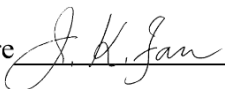
Signature 

Date: Feb 02, 2021

## Revision History

DATE	REVISION	CHANGES
Dec 3, 2019	0a	Initial release
Apr 6, 2020	0b	Update screenshots
Jun 3, 2020	0c	Update photo and diagram
Jul 7, 2020	0d	Update LED behavior
Sep 24, 2020	01	Fix text and layout
Nov 17, 2020	01a	<ol style="list-style-type: none"><li>1. Add FCC/CE regulatory information and FCC statement</li><li>2. Add the method of opening the lower cover</li><li>3. Modify Button section to make it more clear</li><li>4. Update insert SIM card location photo</li></ol>
June 1, 2021	01b	<ol style="list-style-type: none"><li>1. Add iGS03E FCC, CE and MIC regulatory information</li><li>2. Add Waste Electrical and Electronic Equipment Recycling section for appropriate recycling the equipment</li></ol>